

Roma

S6012

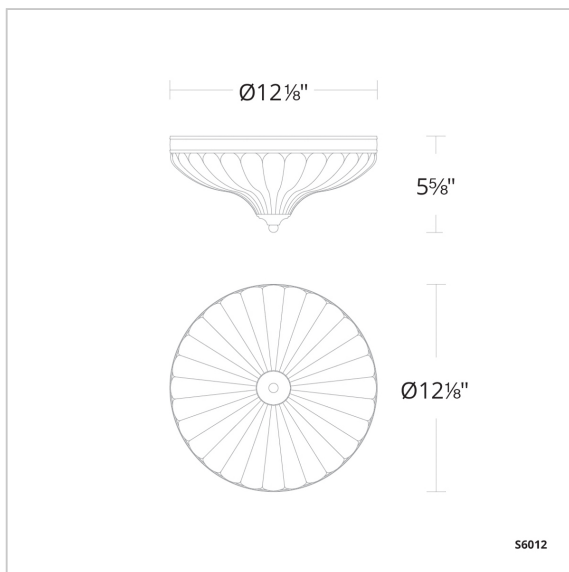

LINE DRAWING



DESCRIPTION

With attention to detail indicative of true luxury, Roma marries sophistication in classic Italianate form and technological advancement. A classic European Optic Crystal shade is intricately cut with double optics and enhanced by primary optics developed by Schonbek, intensifying the fire exhibited for unparalleled delivery.

FEATURES

- Built in color temperature adjustability. Switch from 3000K/3500K/4000K. Switch may be installed in junction box.
- Can be mounted on ceiling or wall in all orientations

CRYSTAL OPTIONS



Optic Crystal
(O)

FINISH OPTIONS



Aged Brass
(-700)



Polished
Chrome
(-702)



Antique
Nickel
(-704)

SPECIFICATIONS

Light Source	LED
CRI	90
Dimming	ELV, Triac
Standards	ETL/cETL, Title 24

REPLACEMENT PARTS

RPL-GLA-6012 - Replacement Glass

Model	Finish	Crystal	Size	CCT	Weight	Voltage	Wattage	LED Lumens	Delivered Lumens
S6012	- 700 - 702 - 704	O	12"	3000K/3500K/ 4000K	10.3lbs	120V	19W	2400	Up To 2000

Example: S6012-7000